

# Flow Visualization

Part 1 (out of 3)



---

---

---

---

---

---

---

---

## Overview: Flow Visualization, Part 1



- Introduction, overview
  - ◆ Flow data
  - ◆ Simulation vs. measurement vs. modelling
  - ◆ 2D vs. surfaces vs. 3D
  - ◆ Steady vs time-dependent flow
  - ◆ Direct vs. indirect flow visualization
- Experimental flow visualization
  - ◆ Basic possibilities
  - ◆ PIV + Example



---

---

---

---

---

---

---

---

# Flow Visualization

Introduction, Overview



---

---

---

---

---

---

---

---

## Flow Visualization



- Introduction:
  - ◆ FlowVis = visualization of flows
    - Visualization of change information
    - Typically: more than 3 data dimensions
    - General overview: even more difficult
  - ◆ Flow data:
    - $nD \times nD$  data,  $1D^2/2D^2/nD^2$  (models),  $2D^2/3D^2$  (simulations, measurements)
    - Vector data ( $nD$ ) in  $nD$  data space
  - ◆ User goals:
    - Overview vs. details (with context)



---

---

---

---

---

---

---

---

## Flow Data



- Where do the data come from:
  - ◆ Flow simulation:
    - Airplane- / ship- / car-design
    - Weather simulation (air-, sea-flows)
    - Medicine (blood flows, etc.)
  - ◆ Flow measurements:
    - Wind tunnel, fluid tunnel
    - Schlieren-, shadow-technique
  - ◆ Flow models:
    - Differential equation systems (ODE) (dynamical systems)



---

---

---

---

---

---

---

---

## Flow Data Specification



- Simulation:
  - ◆ Flow: set of samples ( $n$  dimensions of data), e.g. given on curvilinear grid
  - ◆ Most important primitive: tetrahedron (cell)
- Measurement:
  - ◆ Flow-vectors: reconstruction out of correlations, often calculated on regular grids
- Modelling:
  - ◆ Flow: analytic formula, can be evaluated "everywhere"



---

---

---

---

---

---

---

---

## Data Source – Examples 1/2

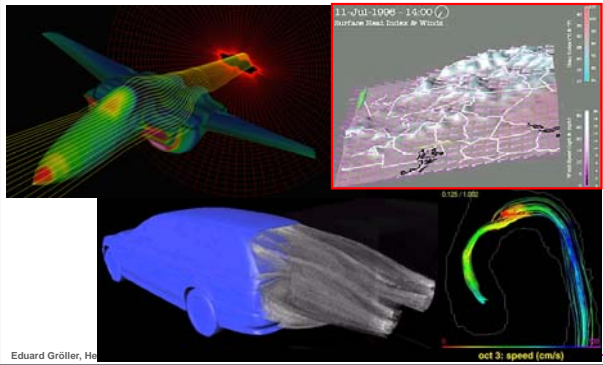

Eduard Gröller, He

---

---

---

---

---

---

---

---

## Data Source – Examples 2/2

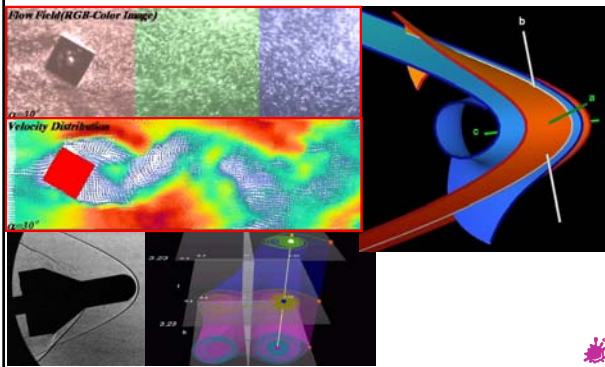

---

---

---

---

---

---

---

---

## Simulation vs. Measurement vs. Modelling



- Simulation:
  - ◆ Flow space modelled with grid
  - ◆ FEM (finite elements method), CfD (computational fluid dynamics)
- Measurements:
  - ◆ Optical methods + pattern recognition, e.g.: PIV (particle image velocimetry)
- Models:
  - ◆ Differential equation systems  $dx/dt$

Eduard Gröller, Helwig Hauser

9



---

---

---

---

---

---

---

---

Comparison with Reality 



Experiment

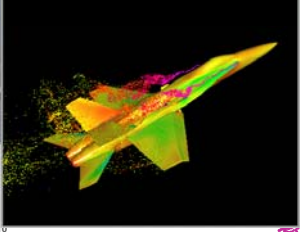

Simulation

Eduard Gröller, Helwig Hauser

---

---

---

---

---

---

---

---

2D vs. Surfaces vs. 3D 

- 2D-Flow visualization
  - ◆ 2D×2D-Flows
  - ◆ Models, slice flows (2D out of 3D)
- Visualization of surface flows
  - ◆ 3D-flows around “obstacles”
  - ◆ Boundary flows on surfaces (2D)
- 3D-Flow visualization
  - ◆ 3D×3D-flows
  - ◆ Simulations, 3D-models

Eduard Gröller, Helwig Hauser 11 

---

---

---

---

---

---

---

---

2D/Surfaces/3D – Examples 

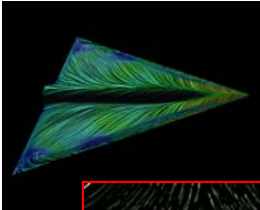

Surface

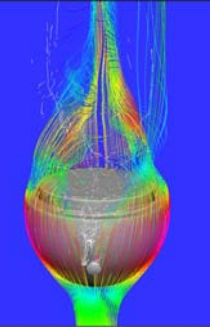

3D

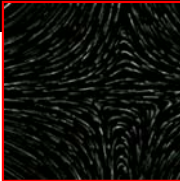

2D

Eduard Gröller, Helwig Hauser

---

---

---

---

---

---

---

---

## Steady vs. Time-Dependent Flows



- **Steady (time-independent) flows:**
  - ◆ Flow static over time
  - ◆  $\mathbf{v}(\mathbf{x})$ :  $\mathbb{R}^n \rightarrow \mathbb{R}^n$ , e.g., laminar flows
  - ◆ Simpler interrelationship
- **Time-dependent (unsteady) flows:**
  - ◆ Flow itself changes over time
  - ◆  $\mathbf{v}(\mathbf{x}, t)$ :  $\mathbb{R}^n \times \mathbb{R}^1 \rightarrow \mathbb{R}^n$ , e.g., turbulent flows
  - ◆ More complex interrelationship



---

---

---

---

---

---

---

---

## Time-Dependent vs. Steady Flow

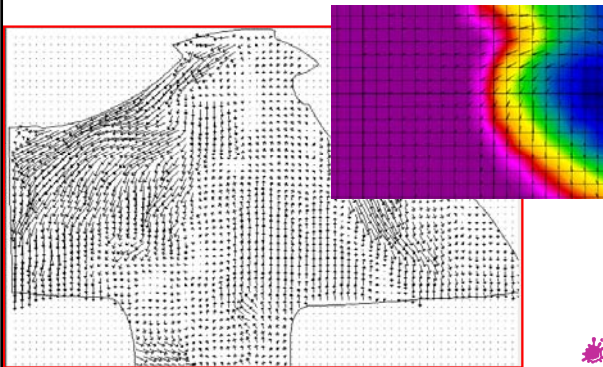

---

---

---

---

---

---

---

---

## Time-Independent (Steady) Flow Data



- **Data size in the course of time:**

Data set name and year	Number of vertices	Size (MB)
McDonnell Douglas MD-80 '89	230,000	13
McDonnell Douglas F/A-18 '91	900,000	32
Space shuttle launch vehicle '90	1,000,000	34
Space shuttle launch vehicle '93	6,000,000	216
Space shuttle launch vehicle '96	30,000,000	1,080
Advanced subsonic transport '98	60,000,000	2,160
Army UH-60 Blackhawk '99	100,000,000	~4,000



---

---

---

---

---

---

---

---

## Time-Independent (Steady) Data

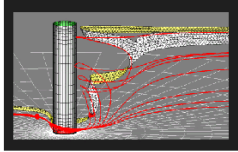

Single Zone  
100K Nodes  
4 MB

(1985)

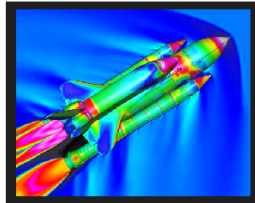

128 Zones  
30M Nodes  
1080 MB

(1996)

Eduar

---

---

---

---

---

---

---

---

## Time-Dependent (Unsteady) Data



### Historical development:

Data set name and year	# vertices	# time steps	size (MB)
Tapered Cylinder '90	131,000	400	1,050
McDonnell Douglas F/A-18 '92	1,200,000	400	12,800
Descending Delta Wing '93	900,000	1,800	64,800
Bell-Boeing V-22 tiltrotor '93	1,300,000	1,450	140,000
Bell-Boeing V-22 tiltrotor '98	10,000,000	1,450	600,000

Eduard Gröller, Helwig Hauser

17



---

---

---

---

---

---

---

---

## Time-dependent (unsteady) Data

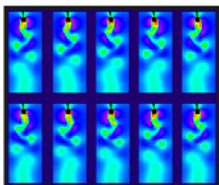

Single Zone  
128K Nodes  
1 GB

(1990)

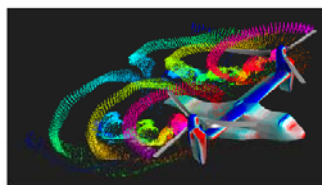

25 Zones (9 Moving)  
2.8M Nodes  
300 GB

(1996)

Eduard Gröller, Helwig Hauser

18



---

---

---

---

---

---

---

---

## Direct vs. Indirect Flow Visualization



- Direct flow visualization:
  - ◆ Overview on current flow state
  - ◆ Visualization of vectors
  - ◆ Arrow plots, smearing techniques
- Indirect flow visualization:
  - ◆ Usage of intermediate representation: vector-field integration over time
  - ◆ Visualization of temporal evolution
  - ◆ Streamlines, streamsurfaces



---

---

---

---

---

---

---

---

## Direct vs. Indirect Flow Vis. – Example

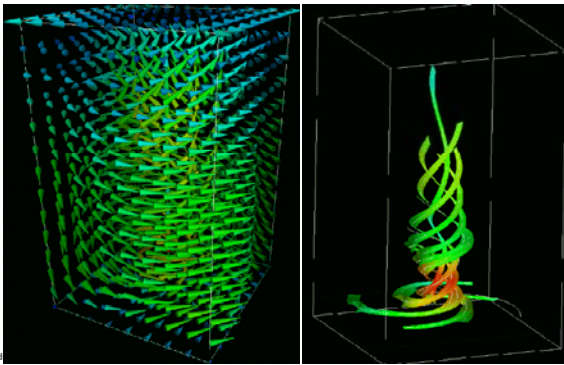

---

---

---

---

---

---

---

---

## Experimental Flow Visualization

Optical Methods, etc.



---

---

---

---

---

---

---

---

## With Smoke resp. Color Injection



- Injection of color, smoke, particles
- Optical methods:
  - ◆ Schlieren, shadows

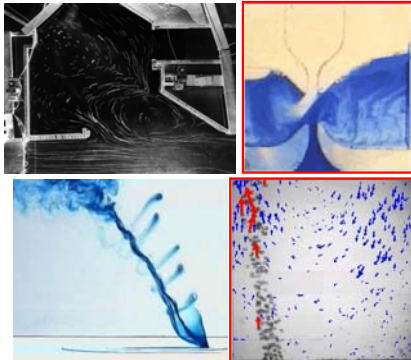

Eduard Gröller, Helwig Hauser

---

---

---

---

---

---

---

---

## Example: Car-Design



- Ferrari-model, so-called five-hole probe (no back flows)

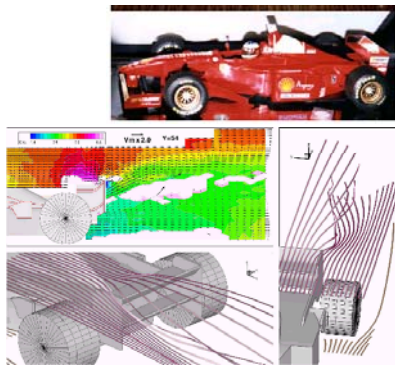

Eduard Gröller, Helwig Hauser

---

---

---

---

---

---

---

---

## PIV: Particle Image Velocimetry



- Laser + correlation analysis:
  - ◆ Real flow, e.g., in wind tunnel
  - ◆ Injection of particles (as uniform as possible)
  - ◆ At interesting locations:
    - 2-times fast illumination with laser-slice
  - ◆ Image capture (high-speed camera), then correlation analysis of particles
  - ◆ Vector calculation / reconstruction, typically only 2D-vectors

Eduard Gröller, Helwig Hauser

24



---

---

---

---

---

---

---

---



**PIV - Measurements**

■ Setup and typical result:

Eduard Gröller, Helwig Hauser 25

---

---

---

---

---

---

---

---

**Example: Wing-Tip Vortex 1/7**

■ Problem: Air behind airplanes is turbulent

Eduard Gröller, Helwig Hauser 26

---

---

---

---

---

---

---

---

**Example: Wing-Tip Vortex 2/7**

■ Vortex: dangerous!

Eduard Gröller, Helwig Hauser 27

---

---

---

---

---

---

---

---

### Example: Wing-Tip Vortex 3/7



- Therefore: keep distance!

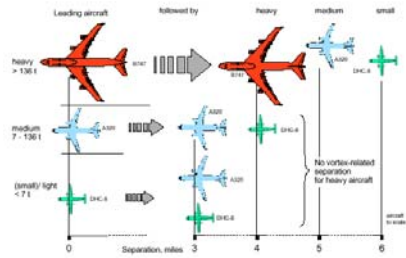

---

---

---

---

---

---

---

---

### Example: Wing-Tip Vortex 4/7



- Tests in wind tunnel:



---

---

---

---

---

---

---

---

### Example: Wing-Tip Vortex 5/7



- Then: Visualization!

- A340 half-model, high lift configuration
- 11 planes measured
- ca. 10.000 field points for each plane
- 110.000 field points in total

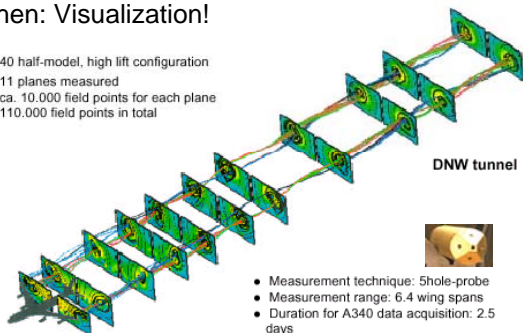

- Measurement technique: 5-hole-probe
- Measurement range: 6.4 wing spans
- Duration for A340 data acquisition: 2.5 days

---

---

---

---

---

---

---

---

### Example: Wing-Tip Vortex 6/7

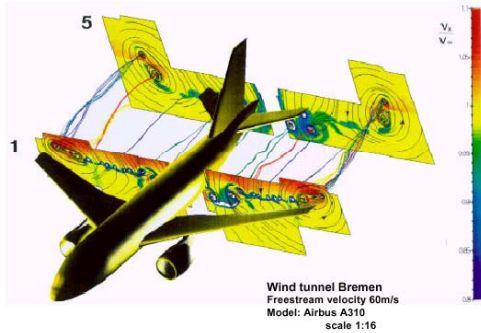

---

---

---

---

---

---

---

---

### Example: Wing-Tip Vortex 7/7

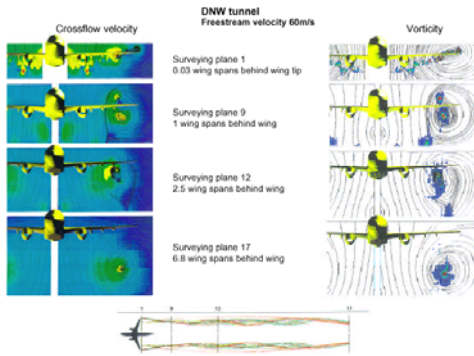

---

---

---

---

---

---

---

---

## Visualization of Models

### Dynamical Systems



---

---

---

---

---

---

---

---

## Dynamical Systems Visualization



### Differences:

- ◆ Flow analytically def.:  
 $\frac{dx}{dt} = v(x)$
- ◆ Navier-Stokes equations
- ◆ E.G.: Lorenz-system:  
 $\frac{dx}{dt} = \sigma(y-x)$   
 $\frac{dy}{dt} = rx-y-xz$   
 $\frac{dz}{dt} = xy-bz$
- ◆ Larger variety in data:
  - 2D, 3D, nD
  - Sometimes no natural constraints like non-compressibility or similar

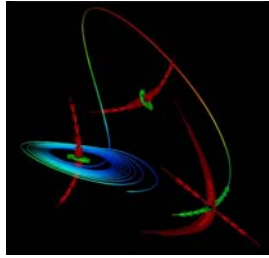

---

---

---

---

---

---

---

---

## Visualization of Models



### Sketchy, "hand drawn"

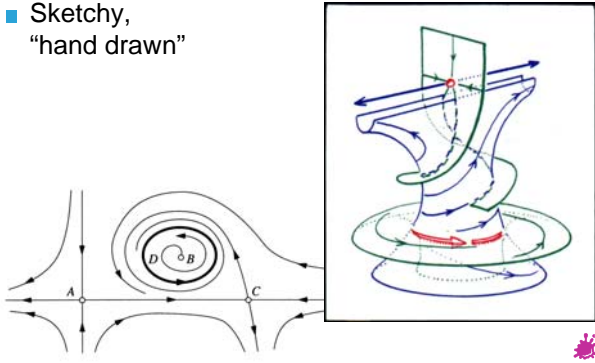

---

---

---

---

---

---

---

---

## Visualization of 3D Models

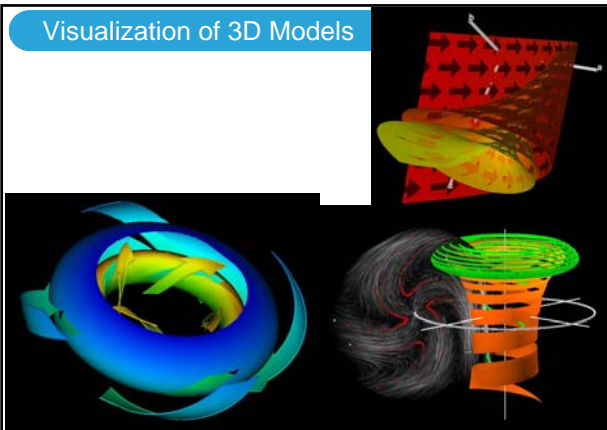

---

---

---

---

---

---

---

---

## Flow Visualization with Arrows

Hedgehog plots, etc.



---

---

---

---

---

---

---

### Flow Visualization with Arrows



#### Aspects:

- ◆ Direct Flow Visualization
- ◆ Normalized arrows vs. scaling with velocity
- ◆ 2D: quite usable, 3D: often problematic
- ◆ Sometimes limited expressivity (temporal component missing)
- ◆ Often used!

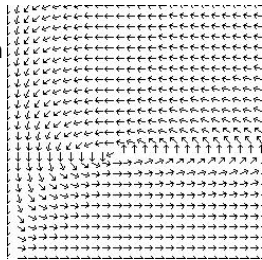

---

---

---

---

---

---

---

### Arrows in 2D



#### Scaled arrows vs. color-coded arrows

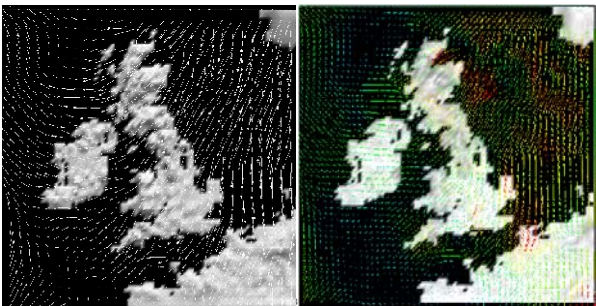

---

---

---

---

---

---

---

**Arrows in 3D** TU  
BERGAKADEMIE

- Following problems:
  - ◆ Ambiguity
  - ◆ Perspective Shortening
  - ◆ 1D-objects in 3D: difficult spatial perception
  - ◆ Visual clutter
- Improvement:
  - ◆ 3D-arrows (help to a certain extent)

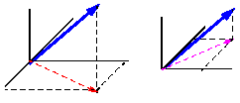
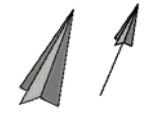
Eduard Gröller, Helwig Hauser 40 ✿

---

---

---

---

---

---

---

---

**Arrows in 3D** TU  
BERGAKADEMIE

- Compromise: Arrows only in slices

**Vector arrows**

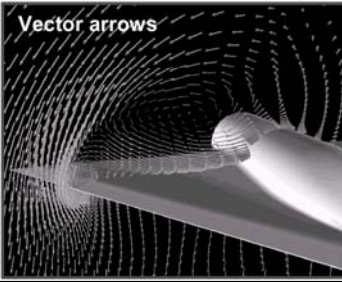

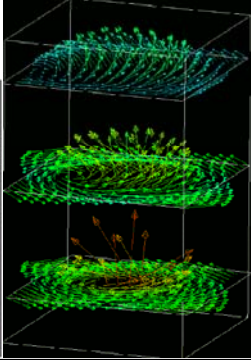

Eduard Gröller, Helwig Hauser 41 ✿

---

---

---

---

---

---

---

---

**Arrows in 3D** TU  
BERGAKADEMIE

- Well integrable within "real" 3D:

11-Jul-1996 - 14:00 📌

Surface Heat Index & Winds

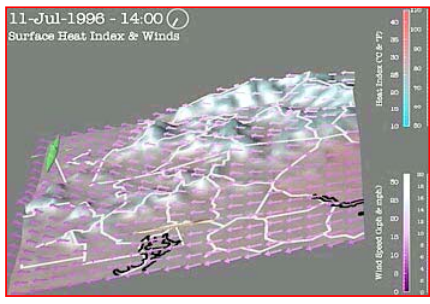

Eduard Gröller, Helwig Hauser 42 ✿

---

---

---

---

---

---

---

---

## Acknowledgments



### ■ For material for this lecture unit

- ◆ Hans-Georg Pagendarm
- ◆ Roger Crawfis
- ◆ Lloyd Treinish
- ◆ David Kenwright
- ◆ Terry Hewitt
- ◆ etc.



---

---

---

---

---

---

---

---